

Instruction Manual

Digital Force Gage

Model RZ Series

This instruction manual covers both Model RZ Series and Model RZ-T Series.



Please read this instruction manual thoroughly before using the gage for the first time.

This manual is very important when using the product. Keep it near the product in such a way that it can be referred to at any time necessary.

AIKOH
ENGINEERING **AIKOH ENGINEERING CO.,LTD.**

(IMPORT & EXPORT DEPT.)

OSAKA 15-7, 2-Chome, Hishie, Higashi-Osaka city, Osaka TEL (072)966-9011 FAX (072)966-9017

TOKYO TANI BUILDING 4F 28-6,1-Chome,Kameido,Koto-ku,Tokyo TEL (03)5858-8816 FAX (03)5858-8836

NAGOYA 210, 2-Chome, Sakuta, Nagakute city, Aichi TEL (0561)64-2331 FAX (0561)64-2332

OSAKA 15-7, 2-Chome, Hishie, Higashi-Osaka city, Osaka TEL (072)966-9011 FAX (072)966-9017

AIKOH ENGINEERING CO.,LTD.

2019.06

To Users of Our Digital Force Gages Precautions for Use

About Overload

Thank you for purchasing our products.

Our Service Section analyzed the cause of troubles of our “digital Force gages” and found that the cause of the most frequent troubles is “Overload (O.L.)” .

If a force exceeding the withstand load is applied to the load cell, the load cell itself is distorted permanently and cannot return to the original condition. This status of the load cell is called “Overload (O.L.)” .

The “load cell” converts small amount of distortion of metal into very low voltage and outputs converted voltage.

The metal can return to the original condition if the applied load is within the allowable range.

However, any “overloaded” load cell cannot return to the original condition.

An “overloaded” load cell must be replaced.

Please understand this and use the load cell with great care.

[Cause of Overload]

A force exceeding the withstand load (150% of the allowable range) is applied to the load cell even instantaneously.

[Advice]

Keep power on when you touch the sensing part.

(An alarm sound is generated when the force reaches the full load).

About battery

This equipment uses a built-in nickel-metal hydride battery.

One of the characteristics of the nickel-metal hydride battery is self-discharge that is after the battery has been charged, it will naturally discharge itself over time.

This means that even when the equipment is not used, the battery voltage continues to drop gradually due to self-discharge and finally the battery will discharge completely.

If the battery has discharged completely, the battery will deteriorate and its charging capacity will decrease or charging itself may be disabled.

In order to prevent such problems, be sure to charge the battery fully after the equipment was purchased.



Also when the equipment is not to be used for a long period of time, be sure to charge the battery once every 3 months.



Table of Contents





1. Safety Precautions	1 ~ 3
2. Checking the Contents of the Package	4
3. Nomenclature	5
4. Description of the Display	6 ~ 7
5. Prior to Use	8
6. Setting of Each Mode	9 ~ 10
7. Flow of Mode Screen Selection	11
7-1. Setting of the comparator function	12
7-2. Concept of the upper limit value and lower limit value	13
7-3. Setting of the stand control function	14
7-4. Precautions for installation on the electric test stand	15
7-5. Changing the screen display direction	16
7-6. Using analog outputs	17
7-7. Minimizing battery consumption for efficient use	17
7-8. Automatic zero resetting	18
7-9. Using the external zero resetting function	18
7-10. Changing over between 3 units	19
8. Measurement 1	
Measurement by use of the memory function	20 ~ 22
Measurement 2	
Measurement by use of the external contact hold	23 ~ 24
Measurement 3	
Connector mating/unmating measurement	25
9. Force Calibration Procedure	26 ~ 28
10. Input/Output	29
10-1. Optional cable	30 ~ 33
11. Specifications and External View	34
12. Warranty	35





Safety Precautions

The precautions presented below are very important for safety and must be observed strictly. The symbols and their meanings are as follows.









	DANGER ... Indicates that it is highly possible that the user will suffer serious injury or loss of life or indicates the possibility of serious consequences depending on situations due to the structure and characteristics of the product if the product is not used properly.
	WARNING ... Indicates the possibility that the user may suffer serious injury or loss of life if the product is not used properly.
	CAUTION ... Indicates the possibility of minor personal injury if the product is not used properly.

 DANGER	
	Do not charge the gage longer than 24 hours.
	Charging will be completed in about 4.5 hours. Charging longer than 24 hours will cause the body to become very hot and depending on situations, may break the incorporated batteries to cause fire.
	Do not use an adapter or cable other than the included AC adapter and dedicated cable for charging.
	The electronic circuit or other parts may be damaged. Such a practice may cause fire or electric shock.

 WARNING	
	Make sure that the object being measured will not fly off.
	When performing measurement which will destroy or cut an object to measure, wear equipment to protect yourself from broken pieces hitting your eyes or body.
	Do not use a damaged hook or deformed hook.
	The hook may be broken or slip out of your hand to cause injury. Or the object being measured may fall to cause serious injury.
	Be sure to insert the AC adapter to the receptacle fully.
	Loose connection may cause a short circuit which can result in electric shock or fire.

 CAUTION	
	Do not plug or unplug the AC adapter with a wet hand.
	You may suffer electric shock.
	Do not hold the cord of the AC adapter to unplug it.
	The cord may be broken to cause electric shock.
	Never disassemble, repair or modify the gage.
	Such a practice may result in malfunction to cause personal injury.

⚠ CAUTION

 <p>Do not apply a force exceeding the rated capacity.</p>	<p>The force sensor may be broken. Application of a larger force may break the body case or internal components to cause accidents.</p>
 <p>Do not use or store the gage in the environment described on the right side:</p>	<ul style="list-style-type: none"> · An environment where the gage may be exposed to water. · An environment where condensation may occur. · A dusty environment. · An environment where the gage may be exposed to oil or chemicals.
 <p>Use the gage within its working temperature range (0 to +40°C).</p>	<p>The use of the gage outside the working temperature range may cause malfunction. The working humidity range is 20% to 60% RH.</p>
 <p>Make sure that mounting screws are of correct length.</p>	<p>When mounting the gage, select such mounting screws that will not enter the body more than 6 mm. The use of a screw longer than this may damage the body case.</p>
 <p>Do not apply a force to the measuring shaft in a bending or torsional direction.</p>	<div style="display: flex; justify-content: space-around; align-items: center;"> <div style="text-align: center;">  <p>CAUTION</p> </div> <div style="text-align: center;"> <p>A force in bending direction</p>  <p>CAUTION</p> </div> <div style="text-align: center;"> <p>A force in torsional direction</p>  <p>CAUTION</p> </div> </div>

Checking the Contents of the Package

Prior to use, make sure that the following items are contained:

1. RZ gage
2. AC adapter MODEL-780
3. European spec replacement plug



4. USB cable Model RZ-USB



5. Instruction manual

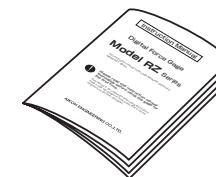

6. Warranty



7. Measurement attachments (RZ-1 (10N) is made of aluminum.)
(RZ-100 (1000N): Only O11B has a larger diameter.)



O11B

O12B

O13B

O14B

O15B

O16B

Display reversing function



When the measuring shaft is directed downward, the display may be reversed upside down to make the display easy to read.
For the reversing procedure, see page 16.

Nomenclature

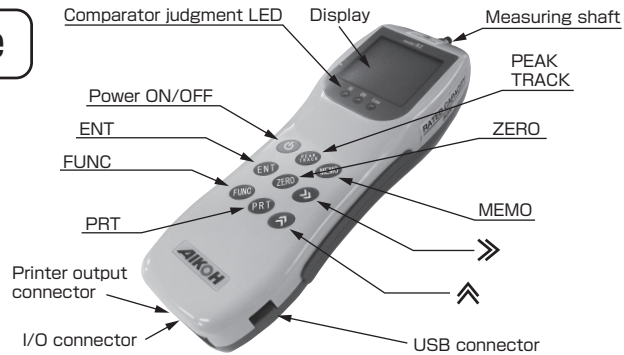

Description of the component devices

- ① Measuring shaft A force is detected by this part.
Do not apply a force exceeding the allowable range to the measuring shaft, as it may cause the gage to fail.
- ② Display Shows the user setting mode and measurement results.
- ③ **ON/OFF** Used to turn the power on and off.
- ④ **ENT** Used to select a user setting mode and make setting.
- ⑤ **FUNC** Used to enter the user setting mode or return to the measurement screen from the user setting mode.
- ⑥ **PEAK TRACK** "P" shown lit or flashing in the display indicates the peak mode. When it is not shown, the mode is the track mode and the display constantly shows the value of a force applied to the measuring shaft.
- ⑦ **ZERO** Used to reset the indicated value to zero.
- ⑧ **PRT** Used to output the indicated value to a printer.
The gage must be connected to a printer with an optional cable in advance.
- ⑨ **MEMO** Each time the key is pressed, the indicated value will be stored in the memory.
- ⑩ **➡** key Normally this is used to change the units of measurement.
- ⑪ **⬆** key Used to change the mode No. in the user setting mode.
- ⑫ Printer output connector When the gage is connected to a Digimatic Mini Processor DP-1VR or Liner Thermal Printer BL2-58SNWJC with an optional cable, measured values can be printed.
- ⑬ I/O connector
- ⑭ USB connector Connect the included AC adapter MODEL-780 and USB cable Model RZ-USB to charge the gage. Also by using the USB cable Model RZ-USB, the gage may be connected to a PC to send and manage data.

Description of the Display

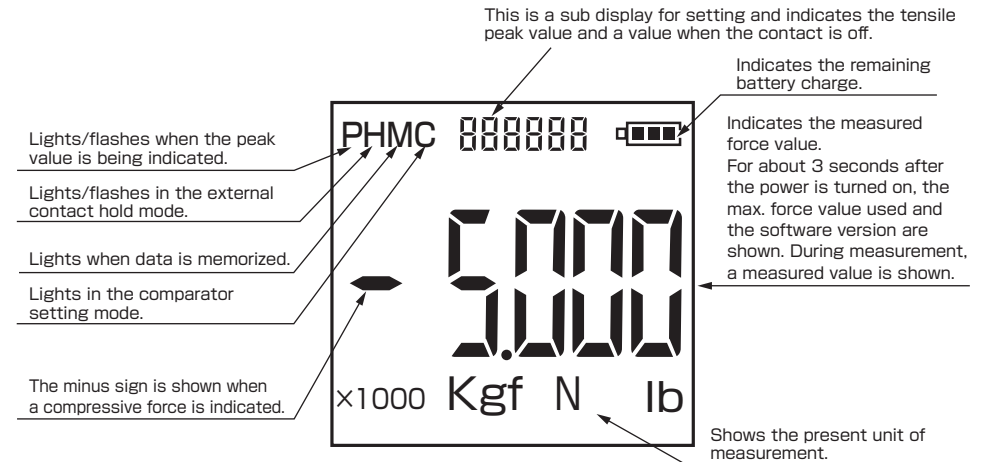

Overload

Overload (O.L.)

When a force exceeding about 110% of the allowable maximum force is applied to the measuring shaft, the display will show "O.L." and a measured value alternately and the warning buzzer will sound. If this happens, immediately stop applying a force.

Continuing the application of a force to the measuring shaft will damage the force sensor or deteriorate the accuracy.

※If the force sensor is broken, it must be replaced/repared and force calibration must be performed.



Battery level low

Low battery (L.b)

When the remaining battery charge drops below 5%, the display will show "L.b." and a measured value alternately and the warning buzzer will sound. When it drops below 3%, the power will be forced to be turned off.

If you turn on the power in this state, the power will be turned off after several seconds.

When the power is on, turn it off. Then connect the included AC adapter and USB cable and charge the batteries. Normally charging will be completed in about 4.5 hours, but the charging time may become longer slightly depending on temperature and other environmental conditions.

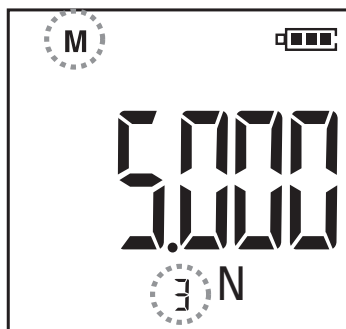

M (Memory mode)

(For storing data in memory, see page 20.)
 Maximum 500 pieces of data or 500 sets of data can be stored in the memory. When data is being stored, this mark lights up.
 Pressing the **MEMO** key records the measured value and the number of pieces of recorded data is shown at the bottom.
 Both PEAK and TRACK values are recorded. However, since the first memory conditions are fixed, changing PEAK/TRACK and units of measurement are not allowed in the second and following operations.
 To store data after changing the conditions, press the **MEMO** key with the **FUNC** key held pressed to clear all stored data once. As soon as data has been cleared, the mark "M" will go out and the number of pieces of data will become zero momentarily and then go out.
 Only when the mark "P" is shown lit in the peak mode, the compressive peak value and tensile peak value are stored as a set in the memory.

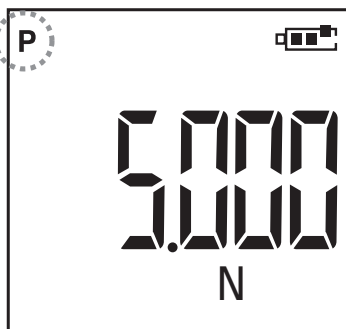

P (Peak mode)

Each time the **PEAK** key is pressed, "P" changes its status as "flashing" → "on" → "off."
 P flashing.....The highest measured value of either tensile or compressive value is acquired as the peak value.
 P on.....The compressive peak value is indicated in a large size and the tensile peak value is indicated in a small size in the sub display.
 P off.....TRACK (track value) is indicated.
 The value is reset to zero with the **ZERO** key or by short circuiting the I/O connector (pin 15 - pin 17).



H (External contact hold mode)

"H" lights up when the I/O connector pin 14 and pin 17 are shorted. A numeric value at the time the contact is on remains shown in the main display.
 "H" flashes when the contact is turned off (pin 14 and pin 17 opened) that takes place after contact on and a numeric value at the time the contact is off remains shown in the sub display.
 "H" goes out after the value is reset to zero with the **ZERO** key or short circuiting the I/O connector pin 15 and pin 17.
 Contact on/off measurement of switches, etc. can be performed.
 ※For details, see page 23.

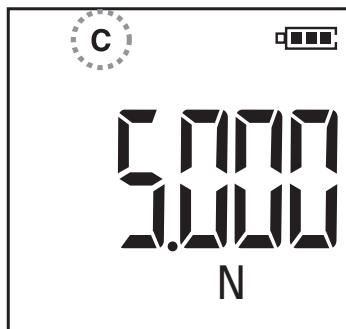

C (Comparator mode)

"C" lights up when upper/lower limit values are set after selecting the comparator function enable in the user setting mode.
 (For setting, see page 12.)
 When the force value is within the range of the set value, "OK" , when outside of the plus range, "Hi" and when outside of the minus range, "Low" are indicated by the LED and corresponding signals are output from the I/O connector.

Prior to Use

<Charging>

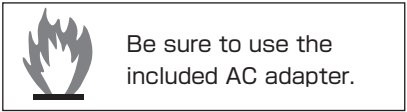

The use of an adapter other than the included AC adapter will destroy the accuracy and in a worse case, may cause malfunction or fire.

The gage has been charged in the factory, but since a minute current is consumed even when the power is off, the charging level might have dropped. Prior to use, charge the gage with the included AC adapter.

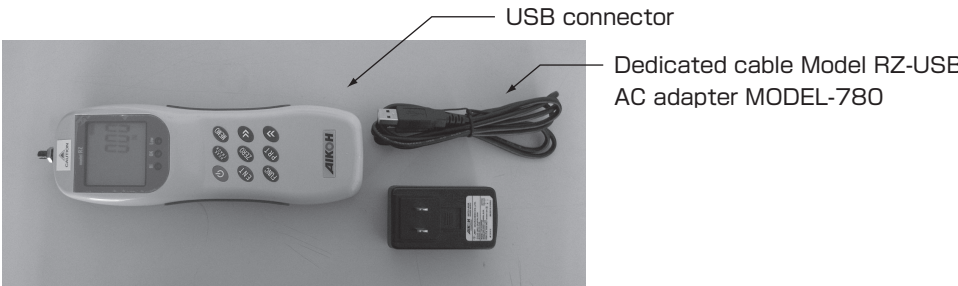

①Connect the dedicated USB cable to the included AC adapter and connect it to the USB connector of the gage.
 Connect the AC adapter itself to an AC outlet.

●After the power is turned on, it takes about 5 seconds for the battery remaining charge mark to indicate the accurate present remaining charge.

※When the gage has been charged fully, charging will be stopped automatically. However, for safety, do not charge the gage longer than 24 hours. Normally the gage will be charged fully in about 4.5 hours from the state of "L.b" (low battery) and can be used continuously for about 30 hours.

●If the battery warning [L.b.] flashes or the warning buzzer sounds immediately after charging, a possible cause is that the incorporated batteries have reached the end of life and the batteries need to be replaced with new ones. However, the gage is designed to disable replacement of the batteries by the user to ensure that the quality of the incorporated batteries will not affect the accuracy of the gage. When the batteries need to be replaced, please contact the dealer or Aikoh Engineering.

User Setting Mode

<Mode selection and setting>

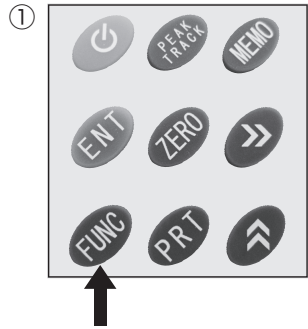

Pressing and holding the **FUNC** key for 3 seconds or longer sets the user setting mode.
At the beginning, the following mode select screen will appear.

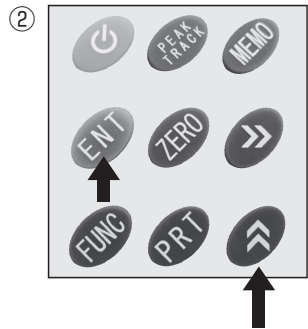

Go to 01 to 13 with the **<<>>** key and select it with the **ENT** key.
On the setting screen, the name of the selected mode is shown at the top.

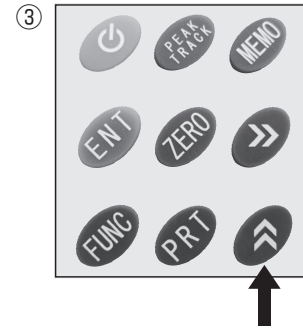
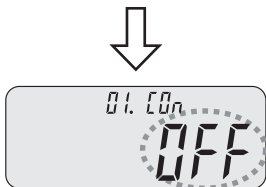

On the setting screen, change the setting with the **<<>>** key.

When the setting is such as ON-OFF, select either one with the **<<>>** key and accept it with the **ENT** key and then return to the select screen.

To enter a numeric value, follow the steps below.



Go to a desired digit with the **>>** key and enter a numeric value with the **<<>>** key. The minus sign is added with the **MEMO** key.

(When the sign “-” is shown, it is a compression value and when no sign is shown, it is a tension value.)



After moving it to a digit to set or change, select a value to set with the **<<>>** key.



To add the minus sign, press the **MEMO** key. Then the sign “-” will be shown on the left side of the value. When the key is pressed again, the sign “-” will go out, indicating that the value is a plus value.



Accept the value with the **ENT** key and return to the mode select screen with the **FUNC** key.

Flow of Mode Screen Selection

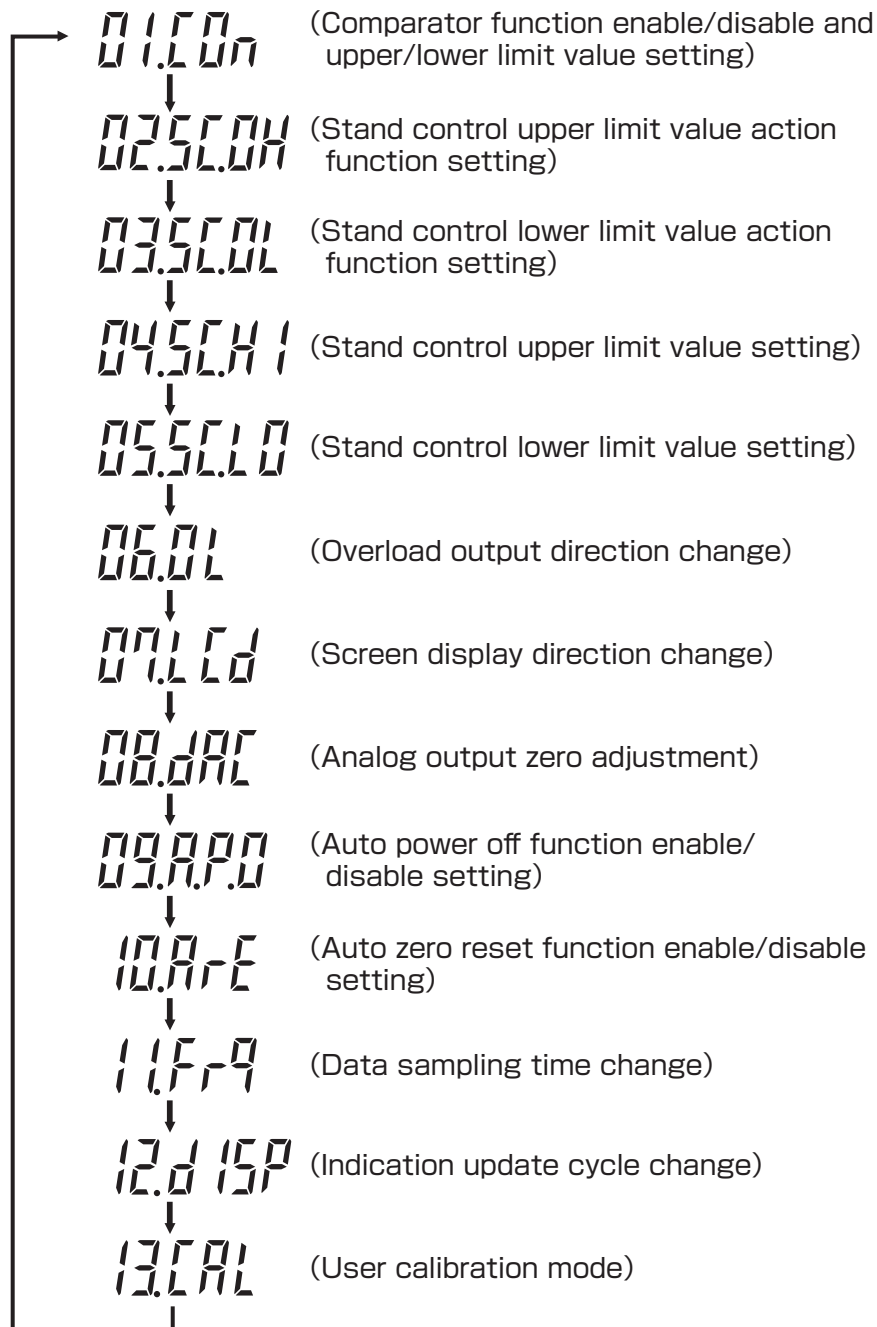

Setting of the Comparator Function

※For the setting procedure, see page 9.

01.00n (Comparator function enable/disable and upper/lower limit value setting)

When "On" (enable) is set in the "On" (enable)/" Off" (disable) selection, the procedure will go to a step of entering a numeric value of HI (upper limit value) or LO (lower limit value).

The status of the force value, whether within the range or outside the plus/minus range of the entered set value is indicated by the LED and can be known by corresponding signals output from the I/O connector.

If the setting of the upper limit value/lower limit value is not correct, the warning buzzer sounds to inform that the setting is not acceptable.

The LED indication and output signals are as follows.

<LED> RZ series

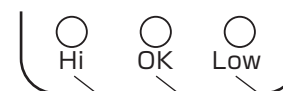

Lights up when the set comparator lower limit value has been reached or exceeded.

Lights up when the force value is between the comparator upper limit value and lower limit value.

Lights up when the set comparator upper limit value has been reached or exceeded.

<Output signals>

26-pin connector (Use the optional cable RZ-OP-2.)

Pin 12 (COM) – Pin 9 (Comparator Low Out) , when the Low LED lights up.

Pin 10 (Comparator Ok Out) , when the OK LED lights up.

Pin 11 (Comparator Hi Out) , when the Hi LED lights up.

※Open collector Lo level output

※Connecting this output under no load is a cause of failure.



Brief Explanation

Concept of the upper limit value and lower limit value



1. When the set values of both the upper limit value and lower limit value are on the plus (tension) side (A, B) in the figure, "A" which is larger is the upper limit value and "B" is the lower limit value.
2. When the set values of both the upper limit value and lower limit value are on the minus (compression) side (D, C) in the figure, "D" which is larger in absolute value is the upper limit value and "C" is the lower limit value.
3. When the set values of the upper limit value and lower limit value are on the plus side and minus side of zero (B, C), "B" which is on the plus side is the upper limit value and "C" which is on the minus side is the lower limit value regardless of their values.

※Both of the comparator function and stand control function operate based on this concept.

Setting of the stand control function

※For the setting procedure, see page 9.

02.50.04 (Stand control upper limit value action function setting)

03.50.01 (Stand control lower limit value action function setting)

This setting is useful when Aikoh's electric test stand compatible with this gage is used in combination. By setting a desired force value, the test stand can be moved up/down or stopped when the actual force has reached the force set value to protect the user's test sample and at the same time, various tests can be controlled in force. There are four types of setting as shown below, from which you can select one.

no no (Disabled) up UP (Up action)
dn down (Down action) st Stop (Stop)

When the actual force reaches each value set in 04.50.01 and 05.50.01, a signal corresponding to the setting will be output from the 26-pin I/O connector provided at the bottom of the gage to activate the action selected here.

<Output signals>

26-pin connector (Use the optional cable RZ-OP-1 or RZ-OP-2.)

Pin 3 (COM) – Pin 5 (Stand Control STOP)

Pin 6 (Stand Control UP)

Pin 7 (Stand Control DOWN)

※Open collector pulse output, withstand voltage 30 V max, on voltage 0.5 V max. (at suction current of 5 mA)

04.50.01 (Stand control upper limit value setting)

05.50.01 (Stand control lower limit value setting)

Here set a force value for 02.50.04 and 03.50.01 to function.

02.50.04 functions at the set value of 04.50.01 and 03.50.01 functions at the set value of 05.50.01

For the concept of the upper limit value and lower limit value, read the brief explanation presented on page 13 and understand them prior to making setting here.

Precautions for installation on the electric test stand

※For the setting procedure, see page 9.

06.01 (Overload output direction change)

If a force exceeding the rated capacity is applied to the measuring shaft, the force sensor may be broken and the gage may fail.

When the gage is installed on Aikoh's electric test stand, an overload signal can be output from the 26-pin I/O connector to the electric test stand to stop the stand. For this purpose, it is necessary to make setting according to the action direction of the electric test stand and the direction of a force to be applied.

06.01 allows selection of either $\overline{L}0n$ or $\overline{u}0n$. For a combination of Aikoh's electric test stand Model 1308 and Model 2257, select $\overline{L}0n$.

※To use the gage in combination with other electric test stand, confirm the stop direction prior to making this setting. If the setting is incorrect, even if an overload occurs, the electric test stand will not stop, breaking the force sensor.

※For connection, use the optional cable RZ-OP-1 or RZ-OP-2.

Vertical/horizontal combined type



MODEL-1308U
Capacity / 1000N
The gage mounting part is moved up and down electrically. The power supply is a multi power supply of 100 V to 240 V.



MODEL-2257
Capacity / 500N
This model is electrical and when the included base plate is exchanged, it can be used either as the vertical type or the horizontal type. The power supply is a multi power supply of 100 V to 240 V.

※The digital force gage is not included with either model.

Changing the screen display direction

※For the setting procedure, see page 9.

07.LCd (Screen display direction change)

The display of the measured value and unit can be reversed. Use this function when mounting the gage on a test stand.

The contents of setting and the display direction are as follows.

$\overline{u}P$... (UP) Upward selected $\overline{d}n$... (DOWN) Downward selected



Direction of the display when the measuring shaft faces upward.

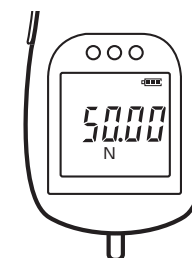

Direction of the display when the measuring shaft faces downward.

Using analog outputs

※For the setting procedure, see page 9.

00.0A_c (Analog output zero adjustment)

An analog voltage is output constantly from the 26-pin connector provided at the bottom of the body. (Approx. $\pm 2V$ at the rated capacity)
The output pin numbers are as follows:



Analog output voltage $\pm 2V/F.S.$ (Rated capacity)

Rated capacity No. 19... Analog Out ($\pm 2V/F.S.$)
NO. 20... Analog GND (A.GND)

※For outputting a voltage, use the optional cable RZ-OP-2.

The analog voltage is output in proportion to the actual force being applied to the sensor, regardless of the indicated value.

Accordingly, a voltage proportional to the actual load by the orientation of the measuring shaft and the mass of the fixture is output. This is not eliminated when the indication is reset to zero, but by adjustment described here, the output voltage when zero resetting is performed can be brought close to zero.

※For setting, connect the optional cable RZ-OP-2 to the gage and connect a digital voltmeter to the signal line corresponding to the analog output pin No. Then, select this item by the setting procedure presented on page 9. Using the  key and  key, change the figure forward or backward to make the voltage indicated on the digital voltmeter close to 0 mV. Finally, press the  key to store the set value.

Minimizing battery consumption for efficient use

09.A.P.O (Auto power off function enable/disable setting)

This gage can run for long hours after it has been charged fully once. If the power is not turned off by a mistake or no operation is performed for about 5 minutes continuously, the auto power off function operates to turn off the power automatically. This function has been set to ON in the factory, but if your environment of use does not permit the power to be turned off, set this to OFF.

0n... (ON) The power is turned off when the nonuse condition continues for approx. 5minutes.

OFF... (OFF) The power is not turned off automatically.

Automatic zero resetting

※For the setting procedure, see page 9.

10.A.r.E (Auto zero reset function enable/disable setting)

With this setting at ON, when the indicated value is within two digits, it is possible to automatically apply automatic zero resetting every about 2 seconds.

This function has been set to OFF in the factory.

0n... (ON) Setting ON

OFF... (OFF) Setting OFF

Using the external zero resetting function

In addition to the  key provided on the gage, it is possible to reset the force value to zero by inputting an external zero reset signal to the 26-pin connector at the bottom of the gage.

Pin No... Pin 15 (Zero In)–Pin 17 (GND)

By short circuiting Pin 15 and Pin 17 shown above, it is possible to reset the force value to zero from external equipment.

※No-voltage contact input

Setting measurement conditions

11.5-9 (Data sampling time change)

Change the internal sampling time of measured values.
Select one from 1 ms, 5 ms, 16 ms, 50 ms, 125 ms and 250 ms. (Factory setting 50 ms)

TRACK mode ... Data is sampled continuously for the set sampling time and indicated according to the set indication update cycle.

PEAK mode ... Data is judged for peak values continuously for the set sampling time and indicated according to the set indication update cycle.

To change the data sampling time, change 12.0 15P (Indication update cycle change) at the same time.

※For communications with a PC, since 1.3 ms is required for transfer of one piece of data, when 1 ms is selected, data is sent every 2 ms.

12.0 15P (Indication update cycle change)

Select one from 1, 2, 5, 10 and 20 times/sec. (Factory setting 5 times/sec)
In either of the TRACK and PEAK modes, data is indicated according to the set indication update cycle.

Changing over between 3 units

Unit change mode (Initial setting: N (Newton), changeable to one of 3 units)

When the power is turned on while pressing the **»** key, "Unit" is shown. Then press the **ENT** key to show "Unit n" (Newton).

Press the **▲** key to change "Unit n" to "Unit 3" (3 units) and accept it with the **ENT** key.

After changing, each time the **»** key is pressed, the unit will be changed in the order of Kgf (kilogram), N (Newton) and lb (pound).

In the factory, the unit has been set to the statutory measurement unit N (Newton) stipulated in the Measurement Act.

Measurement ①

<Measurement by use of the memory function>

■Collection of data by field measurement

The memory function of this gage can store maximum 500 sets of measured force values with the compressive force as "-" and the tensile force as "+." The stored data can be output to a printer and PC.

※When data is collected with the memory function or when collected data has been stored in the memory, "PEAK/TRACK" and units cannot be changed.

To change the conditions, clear all memory data.

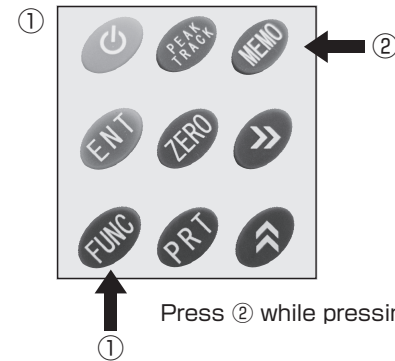

All clear of the memory

To clear data in the memory, press the **MEMO** key while pressing the **ENT** key. Then the memory will be cleared completely.

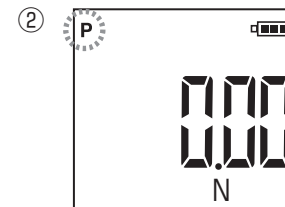

Display mode

Select either the PEAK value or TRACK value according to the nature of measurement.

Each time the **PEAK/TRACK** key is pressed, "P" changes its status in the order of "flashing" → "on" → "off."

P flashing.....The highest measured value of either tensile or compressive value is acquired as the peak value.

P on.....The compressive peak value is indicated in a large size and the tensile peak value is indicated in a small size in the sub display.

P off.....TRACK(track value)is indicated.

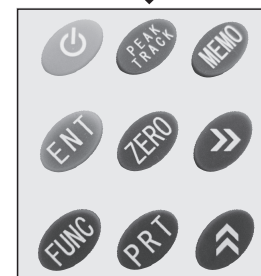

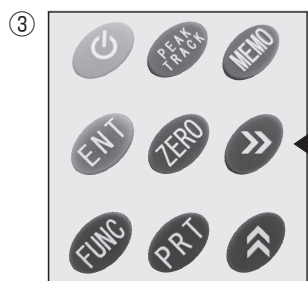

Checking the units

Select a unit of measurement from N, Kgf and lb. (3-unit system)

Each time the key is pressed, the unit is shown below the force value in the order of Kgf, lb and N.

※This function cannot be used when “N” has been set.

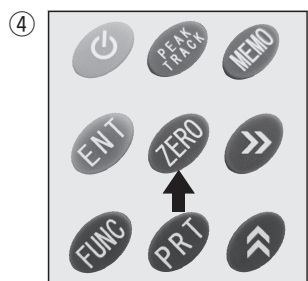

Force zero

Pressing the key without applying a force resets the indicated value to zero.

Continue measurement.

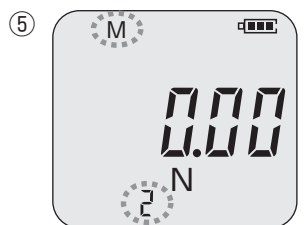

Storing and printing data

If there is data that needs to be stored during measurement, press the key. Then that data will be stored in the memory.

When the key is pressed, the data will be printed.

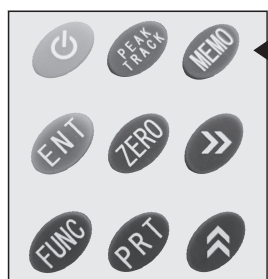

Each time the key is pressed, the number of pieces of data in the memory is shown in the force display for about 1 second, “M” lights up in the upper left corner of the screen and the present number of pieces of data in the memory is shown in the lower right. When data is stored in the memory, the indicated value will be reset to zero and the gage will become ready for the next measurement.

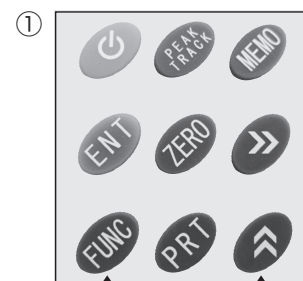

Press ② while pressing ①.

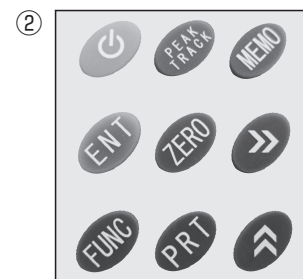

Calling and deleting data

Only the data that was stored last in the memory can be called and deleted.

When the key is pressed while pressing the key, the data stored last will be called. Then pressing the key deletes the called data and the gage will return to the normal operation. If the key is pressed without pressing the key, the called data will be returned to the memory.

Printing data in the memory

The printers that are connectable to this gage are the following two types:

- ① MITUTOYO-made DP-1VA (Mitutoyo Digimatic output connection)
※For connection, use the optional cable RZ-OP-3.
- ② SANEI ELECTRIC-made BL2-58SNWJC (RS232C connection)
※For connection, use the optional cable RZ-OP-4.

When the gage has been connected to a printer, print data in the memory collectively.

When the key is pressed while pressing the key, the data in the memory will be printed one after another.

Measurement ②

<Measurement by use of the external contact hold>



When performing measurement which will destroy or cut an object to measure, wear equipment to protect yourself from broken pieces hitting your eyes or body.

■ Measurement of switch/relay contact force

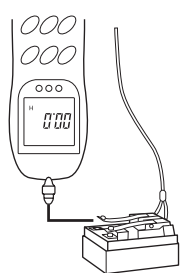

External hold function

A force when a contact is ON or OFF can be measured.

※For measurement, use the optional cable RZ-OP-2.

※No-voltage contact input.

■ Printer



Line Thermal Printer BL2-58SNWJC or Digimatic Mini Processor DP-1VA LOGGER

How to use the external contact hold function 【Example 1】 Switch operating force measurement



BL2-58SNWJC

An example of combination with an electric stand
MODEL-1308U
Capacity / 1000N

0001	+	4.65	N
	-	7.73	N
0002	+	8.53	N
	-	6.85	N
0003	+	0.03	N
	-	0.02	N
0004	+	0.08	N
	-	1.40	N
0005	+	0.34	N
	-	2.39	N

BL2-58SNWJC Printing sample

<Measurement procedure by use of the external contact hold function>

① Connecting the RZ gage and a printer

Connect the I/O connector at the bottom of the RZ gage and a printer with the optional cable. To connect to BL2-58SNWJC, use the optional cable RZ-OP-4 and to connect to DP-1VA, use the optional cable RZ-OP-3.

② Connecting the external contact

The external contact hold signal lines have been provided when the optional cable is used. They are Pin 14 (Hold In) and Pin 17 (GND) of the 26-pin connector at the bottom of the gage.

(The continuous short-circuit/release values of OFF→ON→OFF are held and indicated.)

Contact input diagram

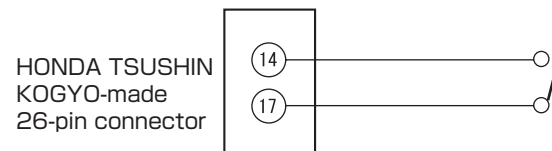

※For the procedure that follows, see "Measurement ①"
<Measurement by use of the memory function>.

Measurement ③

<Connector mating/unmating measurement>

■ For measurement of mating/unmating forces of connectors, etc.

Memory function of the gage

A mating value and unmating value are stored in the memory and indicated by one operation.



① PEAK setting

Press the  key to show "P" in the upper left corner of the screen.

※ The peak mating value is shown in the main display and the peak unmating value in the sub display.

※ When "P" is flashing, only the peak mating value is shown.

② Checking the unit

Select the unit with the  key according to measurement.

③ Connector mating/unmating measurement

Conduct connector mating/unmating measurement. (To hold the gage by hand for measurement, be sure that the gage is held vertically and will not shake during the measurement.)

④ Checking the mating/unmating values

A mating force and unmating force can be measured by one measurement operation. A force value having the minus sign is the mating force and a force value having no sign is the unmating force.

Pressing the  key stores data in the memory of the RZ gage.

After measurement, connect the gage to a printer and print data collectively.

(By pressing the  key with the printer connected, data can be printed individually.)

※ For the procedure that follows, see "Measurement ①" <Measurement by use of the memory function>.

Force Calibration Procedure



Do not use a damaged hook or deformed hook.



Do not apply a force exceeding the rated capacity.

• The hook may be broken or slip out of your hand to cause injury. Or the object being measured may fall to cause serious injury.

• Apply a force to a point where the extension line of the measuring shaft and the hook cross. If a force is applied to the tip of the hook, the hook may be deformed or broken to cause serious injury.

• The force sensor may be broken. Application of a larger force may break the body case or internal components to cause accidents.

• The weight of the fixture will be loaded as a force. Use a fixture the weight of which is less than 10% of the rated capacity of the gage.

• When securing an attachment, do not tighten it with a tool too strongly. A large load will be applied to the sensor to break it. After turning on the power, secure it while checking the indicated value.



Never operate the gage without the standard weight.

If the force fluctuates during operation, accurate force calibration cannot be performed.

In this operation, the numeric value may be changed only within $\pm 10\%$ of the suspended weight in order to prevent abnormal calibration.

①

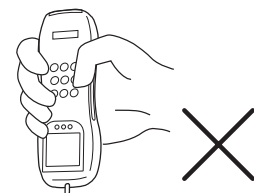
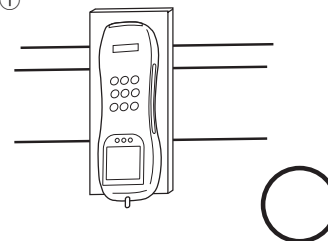

Secure the RZ gage on a test stand.

※ RZ-2 (20N type) is used as an example for explanation.

※ The force calibration cannot be performed while holding the gage by hand.

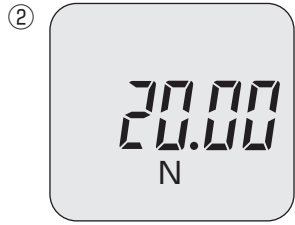

Pressing the  key turns on the power and the rated capacity will be shown (for approx. 3 seconds) .

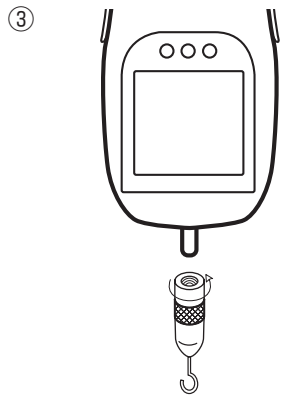



Turn the hook in the arrow direction to mount it on the measuring shaft.

※Be sure to screw in the hook fully. If a fixture (such as a basket) is needed for calibration, hang it on the hook.

Note that if the weight of the hook and fixture (such as a basket) is more than $\pm 10\%$ of the rated capacity of the RZ gage, an error will occur and setting will be disabled and the gage will return to the measurement standby state.



Press and hold the  key for 3 seconds or longer to go to the user setting mode.

Using the  key, go to **13.CAL** and accept it with pressing the  key twice.

Press the  key to reset the indicated value to zero.

※If a package exceeding 20% of the rated capacity is loaded or if the force sensor has been damaged and the zero reset range has been exceeded, the indicated value cannot be reset to zero.

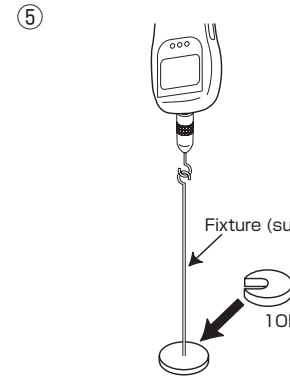

Gently hang the calibration standard weight. The weight must be within a range from 1/3 to 1 of the rated capacity.

Here, since RZ-2 (20N type) is used as an example, hang a weight of 1/2 (10 N).

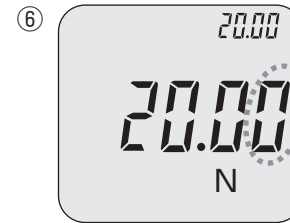



The sub display shows the present force value. Move the flashing digit of the value in the main display with the  key.

After moving it to a desired digit, enter the same value as the mass of the calibration standard weight with the  key.

Each time the key is pressed, the value increases in increments of 1 such as 1, 2, 3, ... 9, 0, 1, 2.

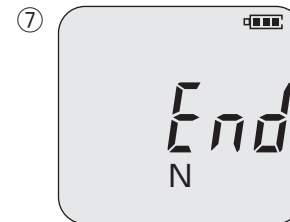
This is a step to set a value that is equal to the calibration standard weight in ⑤.



When a value has been entered, after making sure that the weight is not swaying and press the  key.

"End" will be shown and press the  key several times to reset to zero, then the calibration finish.

At this time, the weight of the standard weight hung in ⑤ is stored as the weight of the set value.

※For example, if the value is set as "10.00" for a 9-N weight, "9 N" will be stored as "10 N" . Be sure to enter the value that is equal to the weight of the standard weight.

※If the entered set value deviates from the present force value indicated in the sub display more than $\pm 10\%$ F.S, the warning buzzer will sound and calibration will not be accepted.

※This force calibration is a simplified calibration procedure. In order to maintain the accuracy of the RZ gage and ensure reliable measurement, it is recommended that the gage be calibrated periodically by an authorized body. For required costs and days, please contact the dealer from whom you purchased the gage.

※The contents of setting and memory data may be changed to the factory setting and data by this calibration and therefore, it is requested that prior to sending the gage for repair or calibration, you keep a record of the data.

Input/Output

[USB output]

The gage may be connected to a PC with the included USB cable to send and manage data.
 For data management, optional software capable of creating graphs is available. Please contact us.
 For installation of software, please see the instruction manual of the optional software.

[Input/output connector]

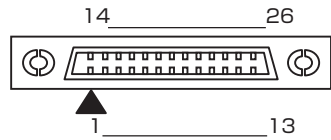

I/O connector, 0.8-mm pitch, 26 pins

Connector pin assignment

pinNo	Signal Name	Description
1	Over Load Up	Overload limiter output signal (Overload output)
2	Over Load Down	
3	Over Load Common	
4	-----	Not used
5	Stand Control Stop	Test stand control output signal
6	Stand Control Up	
7	Stand Control Down	
8	-----	Not used
9	Comparator Low Out	Comparator judgment output signal
10	Comparator Ok Out	
11	Comparator Hi Out	
12	Comparator Common	
13	-----	Not used
14	Hold In	External hold signal input
15	Zero In	External zero reset signal input
16	Print In	External print signal input
17	GND	Ground
18	-----	Not used
19	Analog Out	Analog output
20	Analog GND	
21	-----	Not used
22	-----	Not used
23	-----	Not used
24	-----	Not used
25	-----	Not used
26	-----	Not used

• Signal specifications

- Analog output : $\pm 2V/FS$, 12-bit D/A converter, data update rate 1000 times/second max.
The data update rate varies depending on the setting of the data sampling time.
- Control output signal : Open collector output, withstand voltage 30 V, suction current 10 mA max, on-voltage 0.5 V max.
- Control input signal : 5 V, C-MOS level, 10 k Ω pull-up resistor provided

• Optional Cable
 I/O cable [RZ-OP-1]

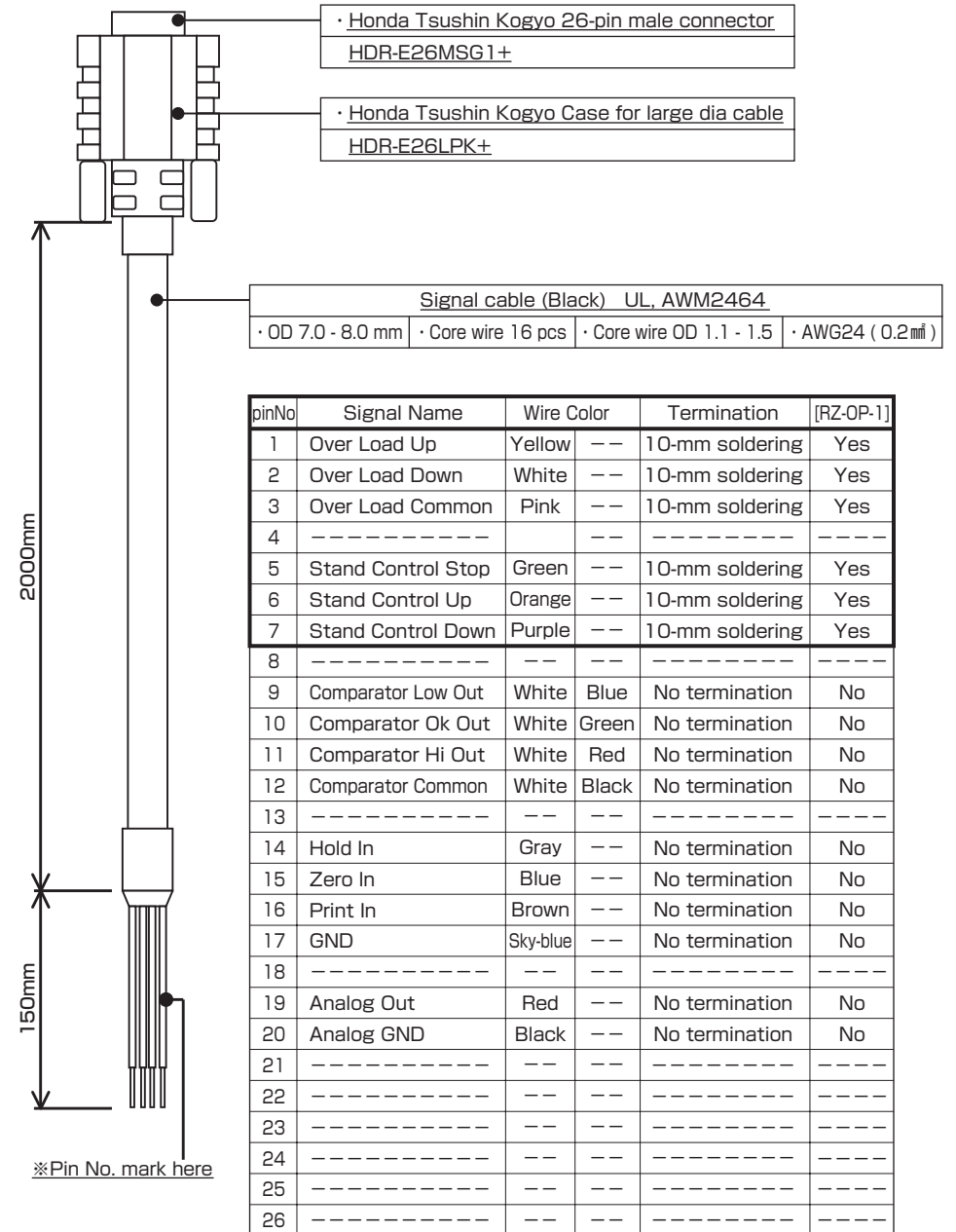

• Optional Cable
I/O cable [RZ-OP-2]

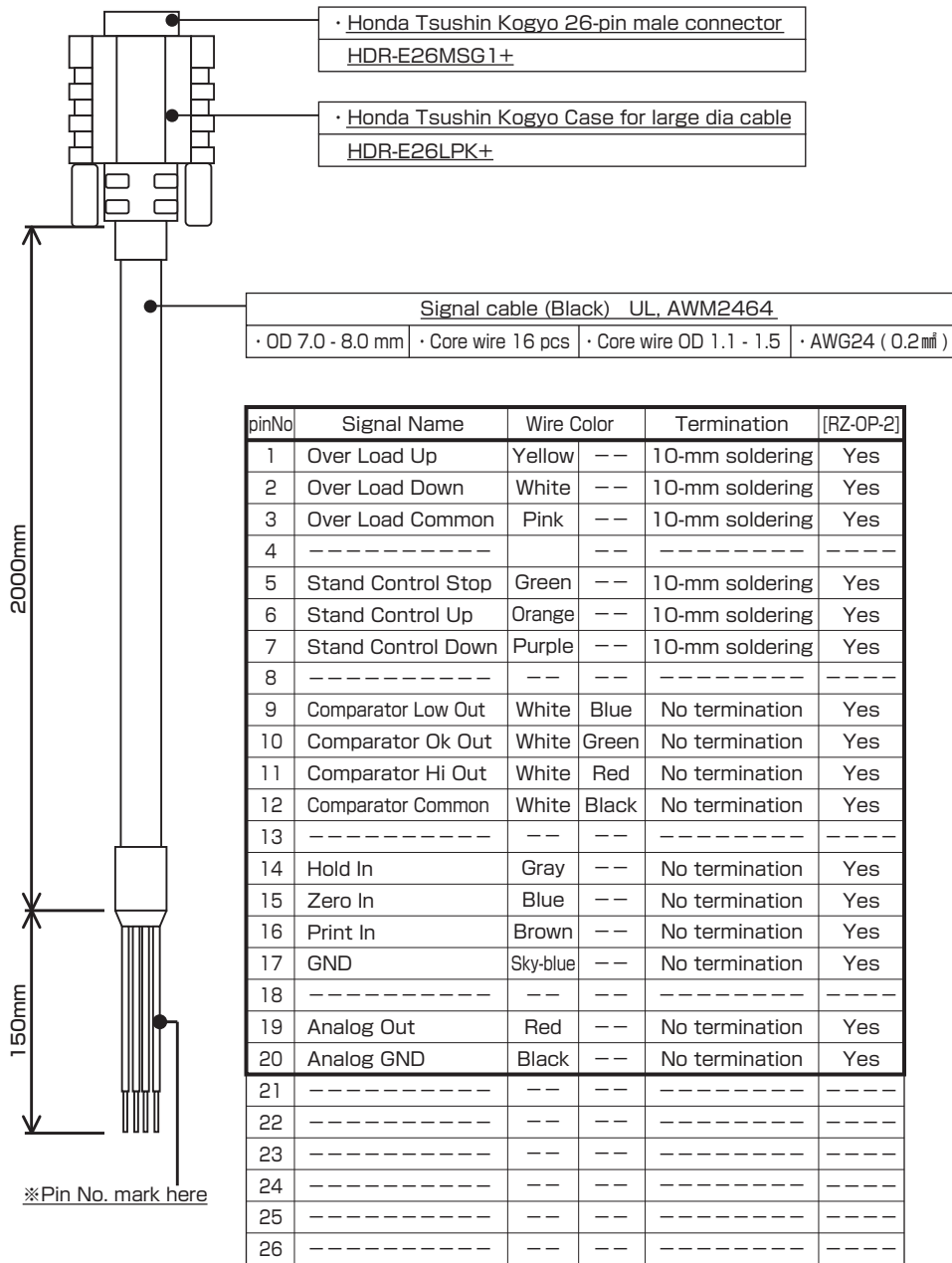

Optional Cable
Mitutoyo DP-1VA Printer Cable [RZ-OP-3]

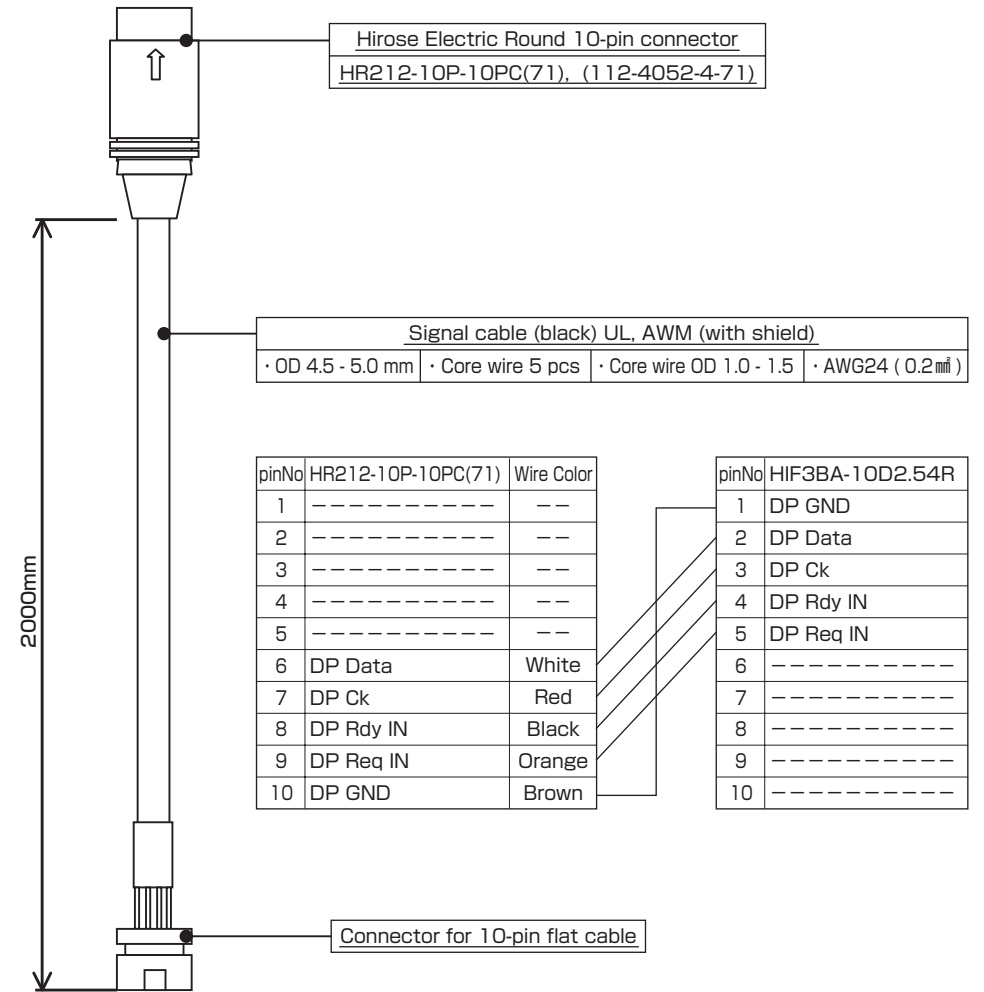

Optional Cable
Sanei Electric Line Thermal Printer Cable [RZ-OP-4]

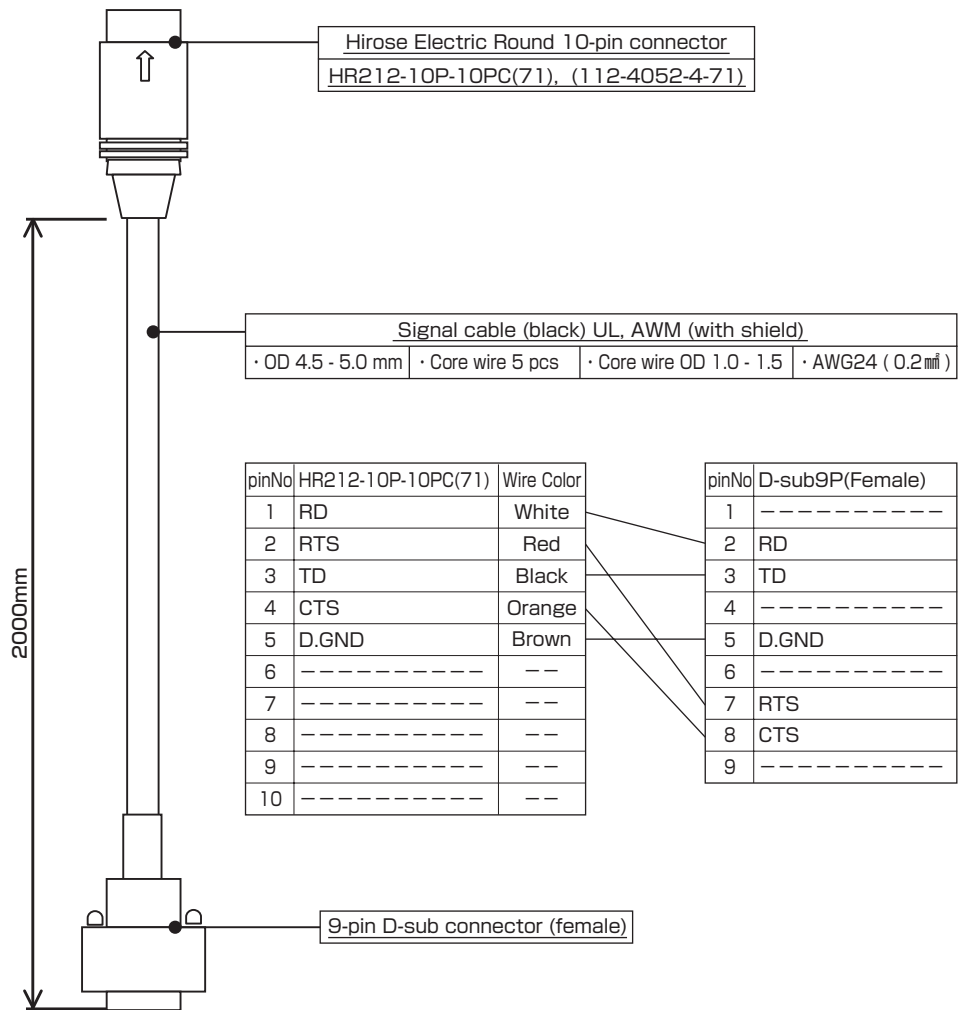

List of Models

Model	RZ-1	RZ-2	RZ-5	RZ-10	RZ-20	RZ-50	RZ-100
Rated capacity (R.C.)	10N (1Kgf)	20N (2Kgf)	50N (5Kgf)	100N (10Kgf)	200N (20Kgf)	500N (50Kgf)	1000N (100Kgf)
Indication range	0.001-10.000N (0.1gf-1.0000Kgf)	0.01-20.00N (1gf-2.000Kgf)	0.01-50.00N (1gf-5.000Kgf)	0.01-100.00N (1gf-10.000Kgf)	0.1-200.0N (10gf-20.00Kgf)	0.1-500.0N (10gf-50.00Kgf)	0.1-1000.0N (10gf-100.00Kgf)
Min. indication resolution	0.001N (0.1gf)	0.01N (1gf)			0.1N (10gf)		

Standard specifications

- Unit of measurement N or (gf) Kgf/N/lb selection
- Accuracy Within $\pm 0.2\%$ of the rated capacity
- Allowable overload 120% of the rated capacity (Overload warning at about 110%)
- Measurement system Track mode / Peak hold mode / Compression/tension peak hold mode selection
- Indication update cycle 1 time/sec, 2 times/sec, 5 times/sec, 10 times/sec, 20 times/sec selection
- Sampling cycle 1 ms, 5 ms, 16 ms, 50 ms, 125 ms and 250 ms selection
- Working temperature range ... 0 to +40°C
- Guaranteed temperature range ... +5 to +40°C
- Continuous working hours 30 hours after full charge
- Power supply Dedicated nickel-metal hydride AAA battery x 3, dedicated AC adapter: Model 780 (5VDC/1000 mA)
Dedicated USB cable: Model RZ-USB
- External dimensions W68 x D40 x H232 mm
- Mass Approx. 375 g

Outside dimensions

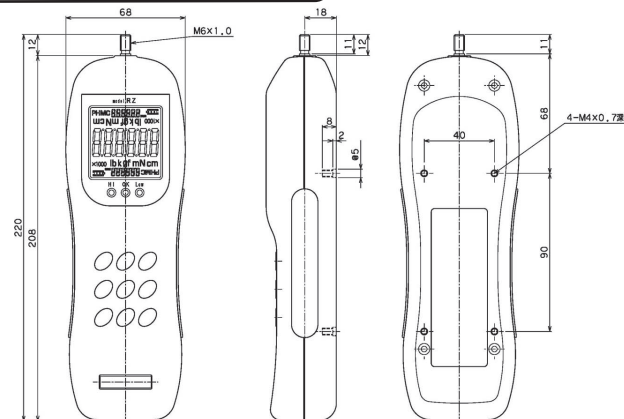

Warranty

MODEL _____

SERIAL No. _____

Warranty period: One (1) year up to _____

This warranty guarantees that the gage will be repaired free of charge only in the following cases:

1. The gage malfunctioned due to an initial defect.
2. The gage failed despite it was used in the correct way.
Please contact a nearest Aikoh Engineering sales office or the dealer from whom you purchased the gage.

3. In the case of the following failures and damages, you are liable for the costs of repair even within the warranty period:

- (1) A failure or damage due to improper handling or use or unauthorized modification or repair.
- (2) A failure or damage that may occur during installation or transportation to an installation place.
- (3) A failure or damage due to fire, smoke, gas, earthquake, lightning and other natural disaster or external causes such as an abnormal voltage.
- (4) A failure or damage due to causes attributable to equipment connected to the gage.

4. When you want the gage to be repaired or serviced, please disconnect other equipment from the gage prior to sending it.

Dealer